

# MURET PROFIL KETCH

MODÈLE DÉPOSÉ INPI

TECHNI'BOX est la solution **design et pratique** pour **intégrer les coffrets techniques** tout en intégrant une boîte aux lettres et un numéro de rue personnalisé.



**LIVRÉ MONTÉ, PRÊT À POSER**  
Praticité de mise en œuvre,  
gain de temps sur pose.



**SERRURE CLÉ TRIANGLE**  
pour accessibilité des coffrets  
par concessionnaires et  
services de secours.



Fabrication  
**100 % FRANÇAISE**



**SIGNALÉTIQUE ADAPTÉE :**  
électricité, gaz ou AEP



**MATÉRIAU DURABLE ET  
RÉSISTANT AUX UV**  
Tenue de la couleur.

## 1 VARIANTE

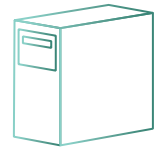

**AVEC  
BOITE AUX LETTRES**

## 3 OPTIONS page 3



**NUMÉRO**  
2 TAILLES



**HABILLAGE BOIS**  
HABILLAGE PORTE

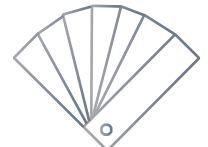

**CHOIX COULEURS**  
BRILLANT/MAT



# MURET PROFIL KETCH

MODÈLE DÉPOSÉ INPI



**AVEC  
BOITE AUX LETTRES**

**1 MTP-50**  
MURET TECHNIQUE TYPE 50  
BAL PROFIL - À DROITE

**2 MTP-50**  
MURET TECHNIQUE TYPE 50  
BAL PROFIL - À GAUCHE

**3 MTP-80**  
MURET TECHNIQUE TYPE 80  
BAL PROFIL - À DROITE

**4 MTP-80**  
MURET TECHNIQUE TYPE 80  
BAL PROFIL - À GAUCHE

**5 MTP-110**  
MURET TECHNIQUE TYPE 110  
BAL PROFIL - À DROITE

**6 MTP-110**  
MURET TECHNIQUE TYPE 110  
BAL PROFIL - À GAUCHE

**1 2**

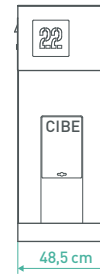
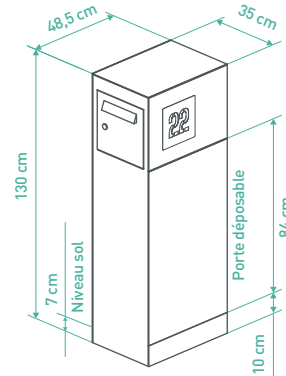

Intérieur platine

Volume intérieur disponible

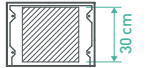
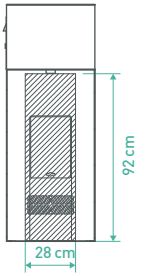

**3 4**

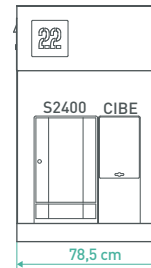
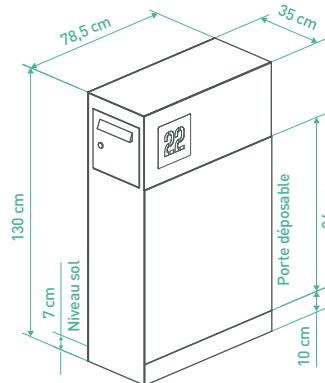

Volume intérieur disponible

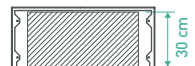
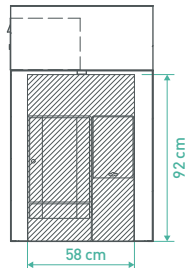

Intérieur platine

**5 6**

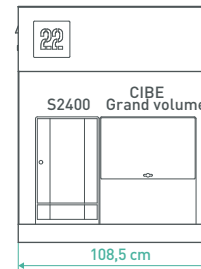
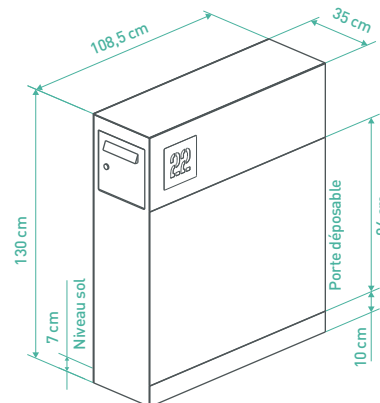

Volume intérieur disponible

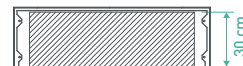
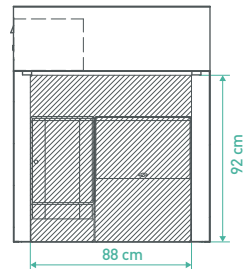

Intérieur platine

# MURET PROFIL KETCH

MODÈLE DÉPOSÉ INPI

## 3 OPTIONS

22

**NUMÉRO\***  
2 TAILLES



Plaque 10 x 10  
RAL 7016



Plaque 20 x 20  
RAL 9006

- \*. Plaque contre vissée sur muret technique
- Vis invisibles
- Thermolaquée Ral au choix.



**HABILLAGE\*  
BOIS**  
HABILLAGE PORTE



- \*. Visserie fournie, porte pré-percée
- Lames en DOUGLAS chanfreins côté et rainure centrale pour fixation sur porte
- Bois origine France



**CHOIX  
COULEURS\***  
BRILLANT/MAT



NOIR

GRIS  
ANTHRACITE

MÉTAL

BLANC

IVOIRE









BLEU  
FONCÉ

VERT  
FONCÉ

CORTEN

ROUGE

\*Tout RAL possible sur demande

	NOIR	9005
	GRIS ANTHRACITE	7016
	MÉTAL	9006
	BLANC	9003
	IVOIRE	1015
	BLEU FONCÉ	5002
	VERT FONCÉ	6005
	ACIER CORTEN	2525
	ROUGE	3020